

Ultravation®

BIOGARDUV™

With integrated fan and ionizer



FS-Series Upper Room Air Disinfection System



- Commercial and institutional applications
- Homes
- Offices
- Medical centers
- Schools
- Industry / Military
- Restaurants
- Pet centers
- Cruise ships
- Hotels / Motels

- **Wall mount and bi-directional ceiling mount models**
- **22- and 33-inch UV lamp models**
- **Bi-polar ionization breaks down odors and airborne toxins, augments disinfection and reduces micro particulates**
- **Quiet 67cfm fan (30 db)**
- **9,000 hour UV lamp life**
- **Energy efficient**
- **Galvanized steel construction**
- **Rugged powder-coat finish**

Safe, effective air disinfection and odor reduction for occupied spaces

Ultravation® BioGardUV™ germicidal ultraviolet air disinfection with ionization destroys airborne pathogens and freshens the air in any room. The system creates a controlled region of germicidal UV-C light in the upper regions of a room. Warmed air carries pathogens into the UV-C zone and are additionally drawn by a fan through the UV lamp chamber. This process exposes them to a lethal dose of high intensity germicidal UV light. Charged ions augment the UV disinfection and move throughout the room to breakdown odors and VOCs. The UV light disinfection field is restricted to the upper area of the room.

UV effectiveness against various microbes

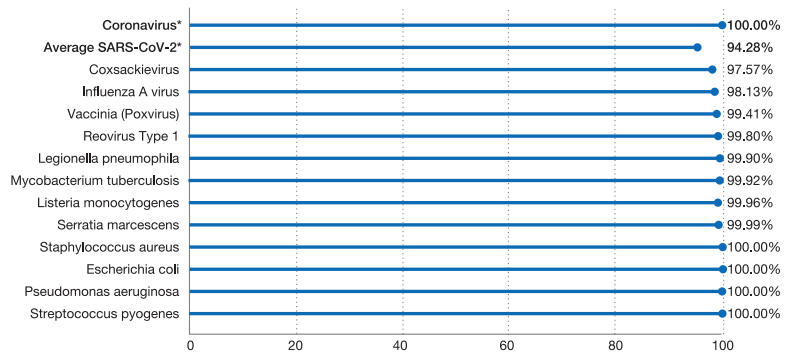

Percentage disinfection calculations are based on intensity at end of (9,000 hour) lamp life. *There are many strains of coronavirus that have been identified. This chart lists just two.

UV air disinfection is recognized and endorsed by ASHRAE* as effective for the reduction of airborne microbes.



FS-33F Wall mount
FS-33F-CR Ceiling mount
 37 5/8" wide



FS-22F Wall mount
FS-22F-CR Ceiling mount
 26 1/8" wide



Bi-directional / Ceiling Mount

Important: The 7-foot minimum installation height requirement must be observed to assure the safety of the occupants.

*The American Society of Heating, Refrigerating and Air-Conditioning Engineers

Ultravation®
 Better Air | Better Water | Better Living™
 ultravation.com

BioGardUV™ Air Flow and Ion Release System

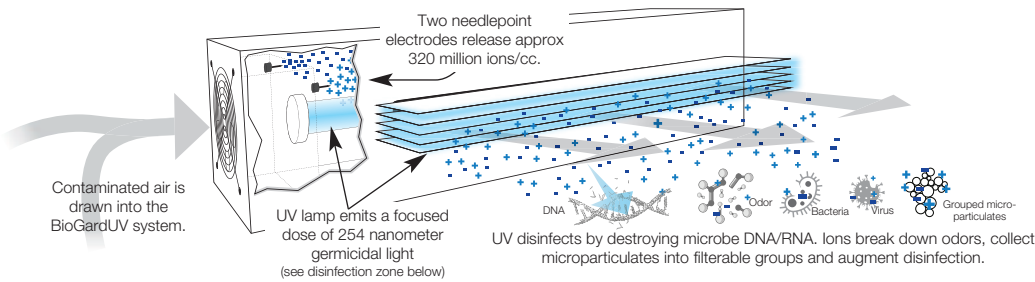

Ultravation®

BIOGARDUV™

FS-Series Upper Room Air Disinfection System with Integrated Fan and Ionizer
Commercial and Institutional Applications

BioGardUV™ Upper Air Irradiance

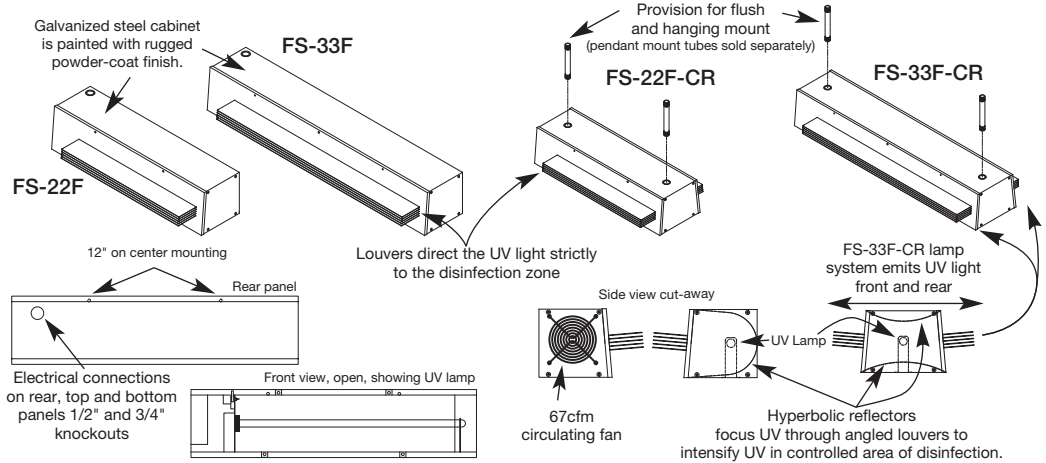
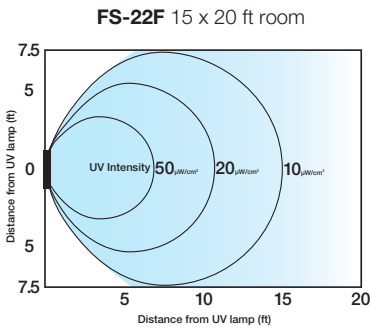

BioGardUV™ Air circulation through disinfection zone

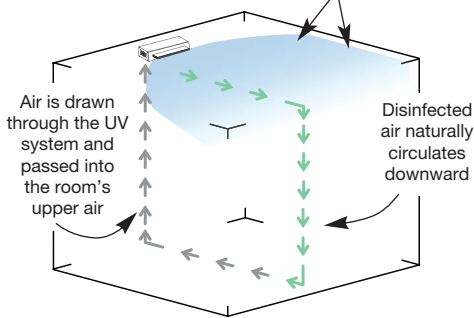

Typical placement for various models

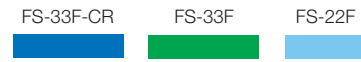

Contact Ultravation for information and advice on the number of units required based on room size, and for placement suggestions.

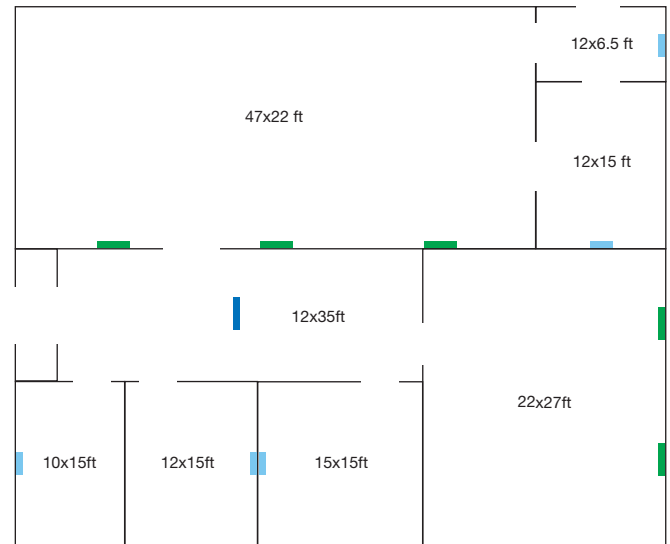

BioGardUV™ Ceiling Mount for extended coverage

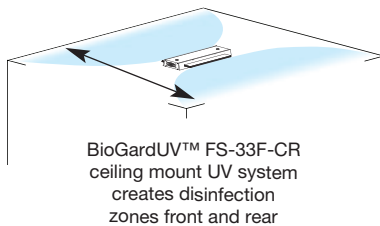

Specifications

Model	Coverage sq. ft.	Total UV-C output	UV lamp wavelength	UV lamp life	Power consumption	Width	Height	Depth
BioGardUV™ FS-22F	225 (15'x15')	10w	254nm	9,000 hrs	36.5VA	26.1"	6.1"	9.2"
BioGardUV™ FS-33F	350 (16'x22')	16w	254nm	9,000 hrs	44.5VA	37.7"	6.1"	9.2"
BioGardUV™ FS-22F-CR	450 (15'x30')	10w	254nm	9,000 hrs	36.5VA	26.1"	6.1"	13.5"
BioGardUV™ FS-33F-CR	700 (16'x44')	16w	254nm	9,000 hrs	44.5VA	37.7"	6.1"	13.5"
						66.29cm	15.49cm	23.37cm
						95.76cm	15.49cm	23.37cm
						66.29cm	15.49cm	34.29cm
						95.76cm	15.49cm	34.29cm

Power: All models auto-sensing 120-277 VAC, 50/60 hz.

Important: When installed, bottom of fixture must be at least 7 feet above the floor.



Ultravation, Inc.

Toll Free 866-468-8247 FAX 802-247-0033 sales@ultravation.com

Member:



EPA establishment number: 074725-VT-001

Form FS121421 ISVT13254 • Copyright © 2021 Ultravation, Inc.

Ultravation®

Better Air | Better Water | Better Living™

ultravation.com